

Emtron SL4 ECU

PRODUCT
DATASHEET

Rev 1.0



SL4



Contents

1.0 General.....	2
2.0 Outputs	3
3.0 Inputs	4
4.0 Voltage and Ground Supplies	5
5.0 Communications	5
6.0 SL4 Pinout	6
6.1 Important Notes.....	8
7.0 Software	9
8.0 Ordering Information.....	9
Appendix A – SL4 ECU Pinout Drawing	10
Appendix B – SL Series ECU Wiring – A21.....	11
Appendix C – SL Series Ethernet Wiring – A25	12

1.0 General

Emtron's SL Series is built upon the outstanding foundation of the KV Series and features the same processing power and logging capacity. This lightweight package is housed in a Billet Aluminium Enclosure and features a 68-pin connector system which is still a very high I/O count. The SL4 ECU will support up to 4 Channels of fully sequential Fuel and Ignition. Up to 32MB permanent memory for on-board logging is available, 4-channel oscilloscope function, DBW control, Knock control using digital filter technology, High Speed Ethernet communications and 3-axis G-force sensing to name a few.

Power Supply

- Operating voltage: 6.0 to 22.0 Volts DC (ECU shutdowns at 24.0V)
- Operating current: 290mA at 14.0V (excluding sensor and load currents)
- Reverse battery protection via external fuse
- "Smart" battery transient protection

Operating Temperature

- Max operating range: -30 to 110°C (-22 to 230°F)
- Recommended operating range: -30 to 85°C (-22 to 185°F)

Physical

- Aluminium 6061 grade CNC billet enclosure
- Enclosure size 120 mm x 130 mm x 27 mm
- Weight: 470g
- Connector system: 68-way Super Seal waterproof connectors with gold plated contacts
 - Pin diameter: 1 mm
 - Current rating: maximum 15A per pin (wire gauge dependant)
 - Connector A: 34 pin Key 2 Super Seal
 - Connector B: 34 pin Key 1 Super Seal

Internal

- Dual 100MHz processors
- 500Mb DDR RAM (0.5Gb)
- 32MB ECU logging memory
 - Over 1200 channels available
 - 1Hz to 500Hz logging rate
- Oscilloscope 4-channel function with 32MB storage
 - Sampling at 100k samples/second
 - Includes Crank Index and Sync sensor inputs
 - Includes Digital Inputs 1-4
- On-Board barometric pressure sensor
 - Range 40 - 115.0 kPa
- 3-Axis accelerometer
 - 16-Bit resolution
 - $\pm 2g/\pm 4g/\pm 8g$ dynamically selectable full-scale
 - Output data rate 500Hz

2.0 Outputs

4x Port Injector Outputs—high ohm

- 70V clamping
- Outputs can be used for ground switching, 6A Continuous, 10A Limit
- All outputs are short circuit and over current protected
- No Flywheel diodes (external diode(s) required for VVT control)

4x Ignition Outputs

- Adjustable TTL Ignition drive current (35mA or 70mA)
- Outputs can be used for ground switching, 1A Continuous, 3A Limit
- All outputs are short circuit and over current protected
- No Flywheel diodes (external diode(s) required for VVT control)

10x Auxiliary Outputs

- Variable Valve Timing (VVT) and Variable Valve Timing Electric (VTiE), Drive by Wire (DBW), dual boost control, gearshift solenoids, stepper motor and many more.
- All outputs have PWM control, maximum frequency = 15 kHz
- Flywheel diodes integrated into all outputs
 - Auxiliary 1-8 Flywheel to the “ECU Supply” pin B1 connector B
 - Auxiliary 9-10 Flywheel to the “ECU 9-12 Supply” pin A34 connector A
- All outputs are short circuit and over current protected

Low Side Drivers

- Auxiliary 1-4: Low Side 4A continuous, 6A peak modulated, 8A limit
- Auxiliary 5-8: Low Side 2.5A continuous, 4A peak modulated, 5A limit

High Side Drivers

- Auxiliary 1-8: High Side 4A continuous, 9A limit

Half Bridge Drivers

- Auxiliary 9-10: Half Bridge 5A continuous and 8A limit. Can be used as Low Side, High Side or together in H-bridge configuration for DC motor control (DBW)

1x EFI Relay Output

- Low Side Driver for relay control. Current limited to 200mA (Output will switch ON when Ignition Switch Input (B4) is greater than 4V)

1x Shield Output

- Connection for Trigger and Knock shielded cables. Short to battery protection

3.0 Inputs

10x Analog Voltage/Temperature Inputs

- Fully configurable including custom calibrations
- Switchable 1k ohm pull-up resistors on ANV 7-10
- Accepts a 0.000 - 5.000V analog input. Resolution is 1.22mV (12-Bit)
- Input Impedance 100k Ohms to ground

6x Digital/Speed Inputs/Switched Inputs

- Frequency range from 0.0Hz up to 30.0kHz on all 6 channels
- Magnetic and Hall effect sensor compatible on DI 1-4 with programmable trigger edge(s)
- Hall effect sensor only on DI 5-6 with programmable trigger edge(s)
- Independent programmable frequency-based arming threshold control, range 0.0 - 12.0V on DI 1-4
- Fixed frequency-based arming thresholds on DI 5-6. Rising = 1.2V, Falling = 1.0V.
- Wheel speed, output shaft speed and other frequency-based signals
- VVT position(s) up to 4 channels available on DI 1- 4.
- ON/OFF switched inputs: AC request, Launch enable, cruise switch, table control switching etc with arming threshold control, range 0.0 -20.0V
- Accepts a 0.0 - 20.0V analog input. Resolution is 4.88mV (10-Bit)
- Switchable 4k7 ohm pull-up resistors on all 6 channels to 10V
- Maximum input signal amplitude +/- 80V

2x Knock Inputs with configurable Frequency and Gain.

- Using Bosch digital knock integrated circuit technology
- Selectable center frequency from 500Hz - 25kHz
- Selectable bandwidth from 100Hz - 5kHz
- Selectable digital filter window; Hamming or Blackman

1x Dedicated Ignition Switch Input

- 6.0 - 20.0V input used for EFI Relay Control. (With input > 4V the EFI Relay output (D9) will switch ON)

2x Crank Index and Sync Engine Decoding Inputs

- Magnetic and Hall effect sensor compatible with programmable trigger edge(s)
- "True" zero crossing detection on magnetic signals for precise engine position decoding.
- Programmable independent arming threshold control from 0.1V to 12.0V
- Switchable 4k7 ohm pull-up resistor to 5V
- OEM patterns supported
- Maximum input signal amplitude +/- 80V
- Input Impedance 39k ohms to ground

4.0 Voltage and Ground Supplies

1x ECU Supply Input

- 15.0A Max (pin limited)
- 6V - 22.0V Range
- Supplies ECU power
- Supplies power to Auxiliary 1-8 High Side Drivers

1x Auxiliary 9-10 Supply Input

- 15.0A Max (pin limited)
- Power supply for Auxiliary channels 9 -10. (See SL Series Power Distribution Wiring - A18.pdf for more information on how this should be wired. Also see Section 6.1)

1x 5.0V Sensor Supply

- 5V Vref1 output current 250mA

1x 8.0V Sensor Supply

- Output current 400mA

2x ECU Main Grounds

- 15.0A per pin, total 30A

1x Sensor 0V Reference

- Analog Sensor 0V Reference with short to battery protection(See note in Section 6.1)

NOTE: The **Sensor 0V Reference** pin(s) are specialised ground outputs for all analog sensors. Connect direct to the sensor 0V pin, **DO NOT** connect to the Engine Block or ECU Ground.

5.0 Communications

- 1x high speed Ethernet 100Mbps
- 1x CAN 2.0B 1Mbps/ 6 Channels per node, total 64 messages.

6.0 SL4 Pinout

Connector A: Injection/Ignition/Auxiliary Outputs (15.0A Max continuous current - wire gauge dependant)

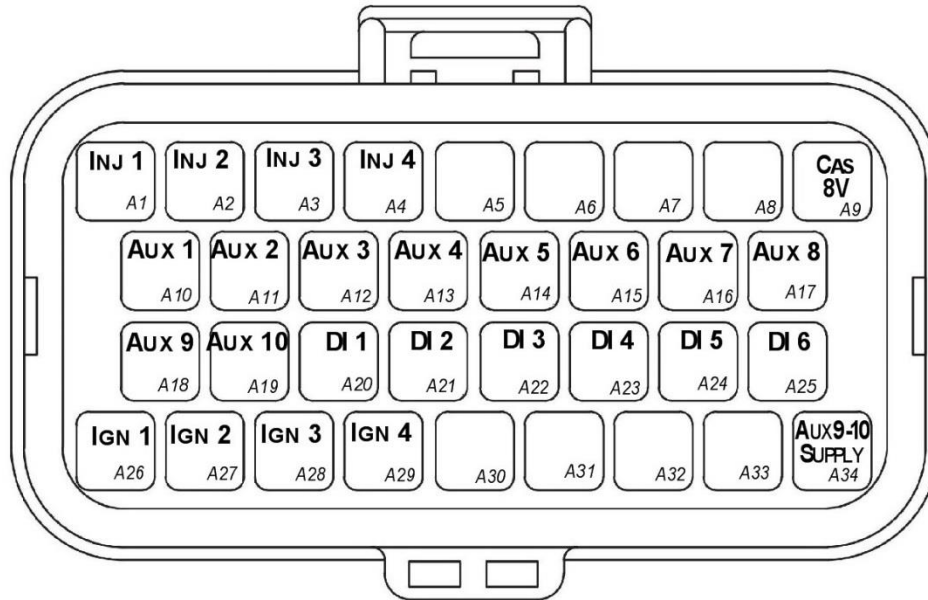

Looking into ECU connector

Pin	Channel Name	Pin	Channel Name
A1	Injection Channel 1	A18	Auxiliary Output 9
A2	Injection Channel 2	A19	Auxiliary Output 10
A3	Injection Channel 3	A20	Digital Input 1
A4	Injection Channel 4	A21	Digital Input 2
A5	NC	A22	Digital Input 3
A6	NC	A23	Digital Input 4
A7	NC	A24	Digital Input 5
A8	NC	A25	Digital Input 6
A9	Sensor Supply 8V	A26	Ignition Channel 1
A10	Auxiliary Output 1	A27	Ignition Channel 2
A11	Auxiliary Output 2	A28	Ignition Channel 3
A12	Auxiliary Output 3	A29	Ignition Channel 4
A13	Auxiliary Output 4	A30	NC
A14	Auxiliary Output 5	A31	NC
A15	Auxiliary Output 6	A32	NC
A16	Auxiliary Output 7	A33	NC
A17	Auxiliary Output 8	A34	Auxiliary Output 9-10, 14V Supply

Connector: B Signal/Power/Communications/Triggers/Knock

(15.0A Max continuous current - wire gauge dependant)

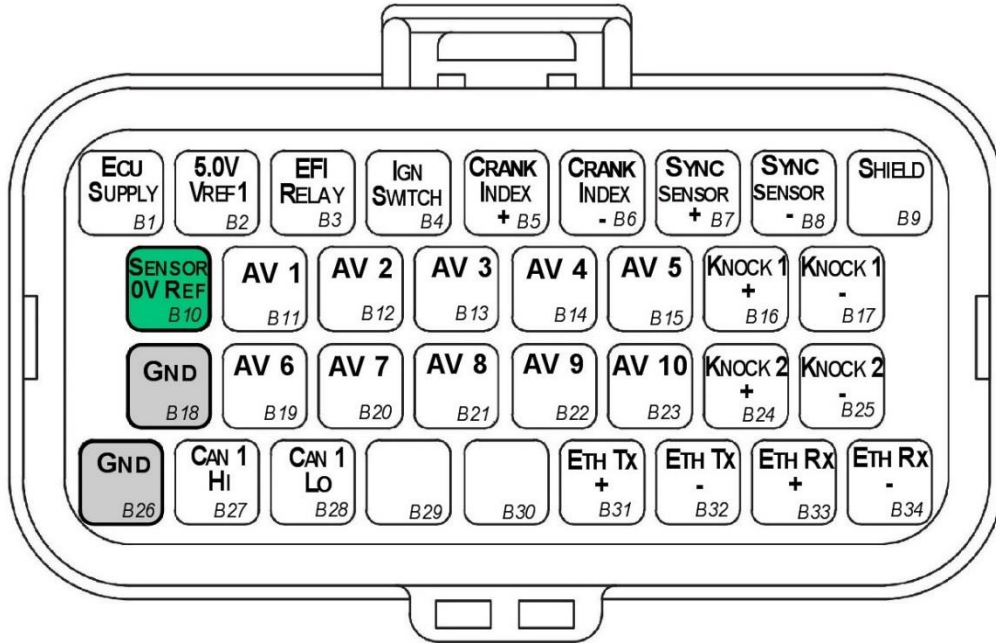

Looking into ECU connector

Pin	Channel Name	Pin	Channel Name
B1	ECU 14V Supply	B18	ECU Ground
B2	Sensor Supply Vref1: 5.0V	B19	Analog Input Channel 6
B3	EFI Relay Output (Low Side 200mA)	B20	Analog Input Channel 7
B4	Ignition Switch Input	B21	Analog Input Channel 8
B5	Crank Index Sensor +	B22	Analog Input Channel 9
B6	Crank Index Sensor -	B23	Analog Input Channel 10
B7	Sync Sensor +	B24	Knock 2 +
B8	Sync Sensor -	B25	Knock 2 -
B9	Shield (Crank/Sync/ Knock)	B26	ECU Ground
B10	Analog Sensor 0V Reference	B27	CAN 1H
B11	Analog Input Channel 1	B28	CAN 1L
B12	Analog Input Channel 2	B29	NC
B13	Analog Input Channel 3	B30	NC
B14	Analog Input Channel 4	B31	Ethernet Tx +
B15	Analog Input Channel 5	B32	Ethernet Tx -
B16	Knock 1 +	B33	Ethernet Rx +
B17	Knock 1 -	B34	Ethernet Rx -

6.1 Important Notes

Analog Sensor 0V Reference (Pin B10)

This pin should be connected directly to the 0V (Ground) pin on any low current analog sensor, for example Pressure or Temperature.

- **DO NOT** connect the ECU pin B10 directly to the Engine Block or ECU Ground. These are dedicated and specialised ground outputs for all analog channels and should be connected directly to the sensor.
- **DO NOT** connect frequency-based sensors to these pins; for example, an Ethanol content sensor. The sensor 0V pin should be connected to the ECU ground.

Half Bridge Driver Power Supply Input (Pin A34)

Pin A34 is a dedicated power supply for Auxiliary Channels 9-10. Power must be supplied to this pin for these channels to operate correctly. In non-DBW (Drive by Wire) applications the ECU Supply power can be shared, assuming the wire gauge has a sufficient rating for the current demand. In DBW applications power to this pin **MUST** come from an ECU controlled DBW Relay.

7.0 Software

Emtron's comprehensive Emtune tuning software is used to connect to the ECU.

- Microsoft Windows™ 7 -10 compatible
- Free licence
- Memory requirements: 0.5GB RAM
- ECU connection using Ethernet, IPV4 protocol
- Tuning and data analysis
- PC and ECU data logging
- Live pause and data playback
- Advanced tuning functions
- Diagnostics
- Oscilloscope display

8.0 Ordering Information

Product	Part Number
Emtron SL4 ECU	1912-042
Emtron Ethernet Tuning Cable (1.5m)	553-15
Emtron Communications Cable, Superseal to Emtron Connector 200mm	533-02

Appendix A – SL4 ECU Pinout Drawing

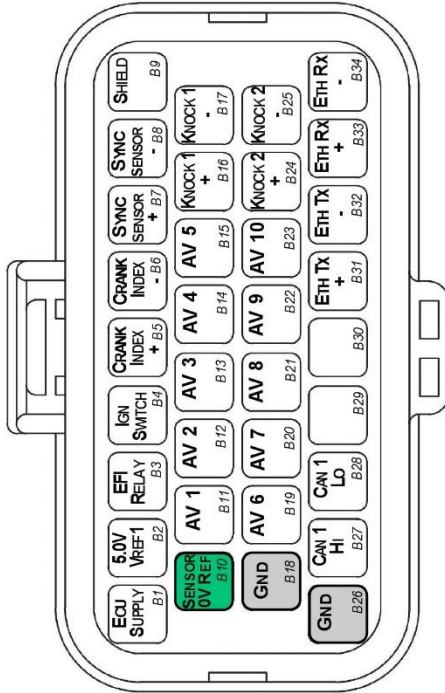

LOOKING INTO ECU

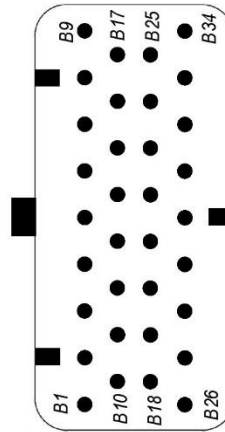

CONNECTOR B

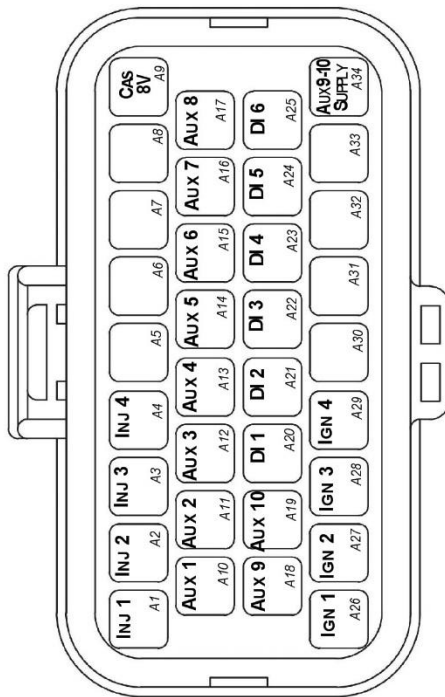

LOOKING INTO ECU

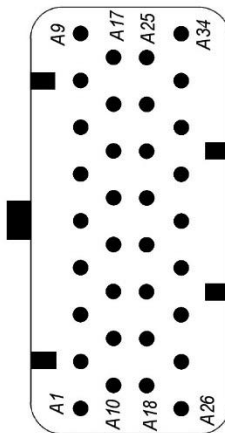

CONNECTOR A

NOTE: The **Sensor 0V Ref** pin is a specialised ground output for all analog sensors. Connect direct to the sensor 0V pin. **DO NOT** connect to the Engine Block or ECU Ground.



Title: SL4 ECU Pinout

Date: 15/04/2018 | Revision: 1.1

Drawing Number: A4

Appendix B – SL Series ECU Wiring – A21

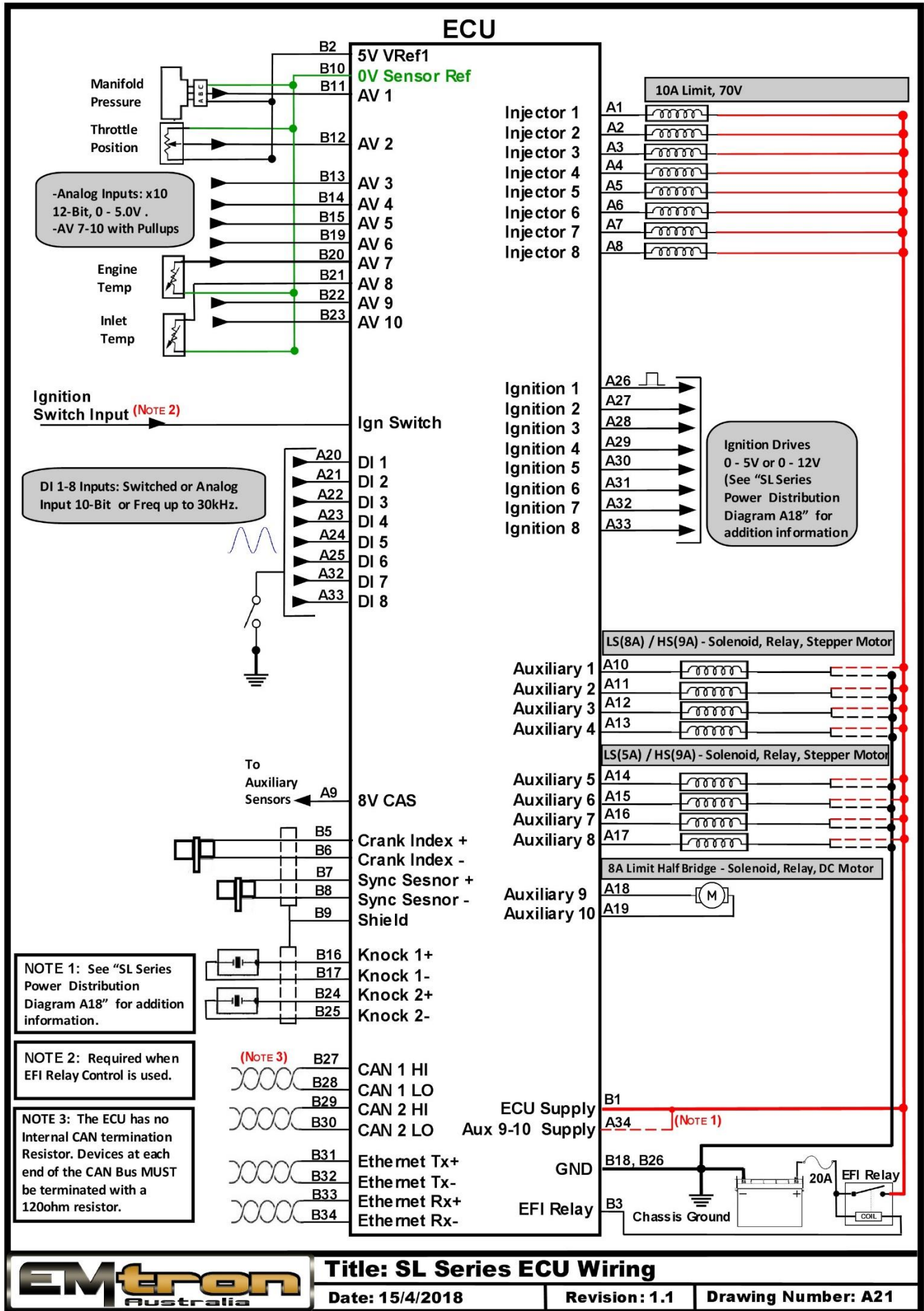

Appendix C – SL Series Ethernet Wiring – A25

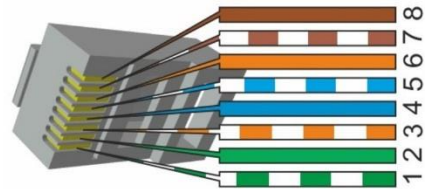

Emtron Ethernet Pinout

RJ45 Pin	Emtron Pin	Description	Wire Colour / Cat 5e Standard
1	B31	Ethernet Tx +	white/green
2	B32	Ethernet Tx -	green
3	B33	Ethernet Rx +	white/orange
6	B34	Ethernet Rx -	orange



Title: SL Series Ethernet Pinout

Date: 08/05/2018 | Revision: 1.1

Drawing Number: A25

Emtron Australia Pty Ltd
Unit 8, 36 Lidco Street
Arndell Park NSW 2148
Australia

(See the www for contact information)

www.emtron.world

www.emtronaustralia.com.au